

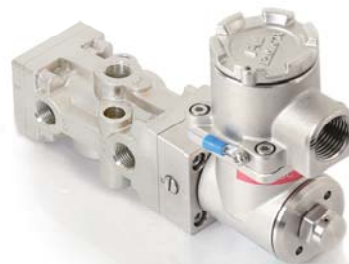

ESV Series Solenoid Valve



All innovation
on driving your valve automation

www.powergenex.com





**Explosion proof solenoid valve
for a confident control under
rough working environments**

Features

- ▶ Rugged aluminum die-cast housing or Stainless steel 316
- ▶ Rotatable valve head for optimal mounting
- ▶ Direct NAMUR mounting or screw mounting
- ▶ Usable up to SIL3 acc. to IEC 61508
- ▶ KCs - certified flameproof Ex d IIC , Ex tb IIC
- ▶ NEPSI - certified flameproof Ex d IIC , Ex tb IIC
- ▶ IECEX - certified flameproof Ex d IIC , Ex tb IIC
- ▶ ATEX - certified flameproof Ex d IIC , Ex tb IIC

Specifications

Model	ESV-S	ESV-D
Operating Air Pressure	1.5 - 10 bar	
Air Supply (Max.)	15 bar	
Operating Voltage / Power	AC110V : 6.8W / AC220V : 6.4W / DC 24V : 3.4W	
Voltage Tolerance	10%	
Frequency	50Hz / 60Hz	
Explosion Proof Class	Ex d IIC T6 / T5 / T4, Ex tb IIIC T85 / T100 / T135, IP66	
Operating Ambient Temperature	T6 : -30 - +50 T5 : -30 - +65 , T4 : -30 - +80	
Flow Capacity(Cv)	0.9	
Mounting Configuration	NAMUR or screw interface	
Pneumatic Connections	PT(Rc) 1/4 or NPT 1/4	
Electrical Connection	PF(G) 1/2 , NPT 1/2 , M20 x 1.5	
Coil Insulation Grade	Class F / Class H	
Operating type	Single coil	Dual coil
Duty Cycle	100%	
Valve body material	Aluminum die-cast or Stainless steel 316	
Coil housing material	Aluminum die-cast or Stainless steel 316	
Weight (Valve body / Coil housing)	Aluminum / Aluminum : 0.9 kg Aluminum / SS316 : 1.9 kg SS316 / SS316 : 2.3 kg	Aluminum / Aluminum : 1.4 kg Aluminum / SS316 : 2.5 kg SS316 / SS316 : 3.3 kg

Rotatable Valve Head

The ESV valve head can be rotated by 90° to the right or to the left for an optimal mounting as shown below

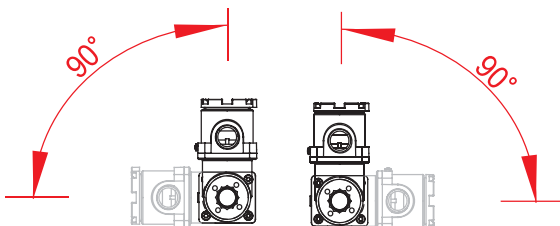

Mounting

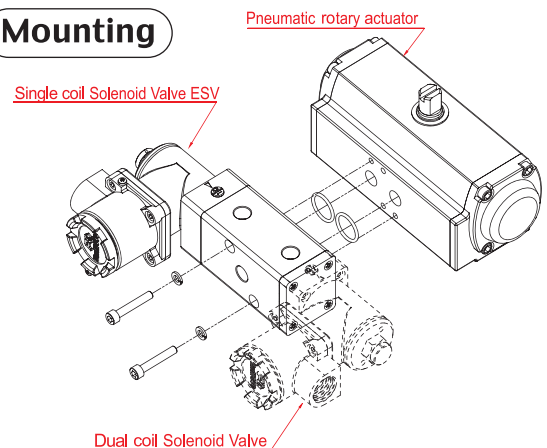



**Explosion proof solenoid valve
for a confident control under
rough working environments**

Features

- ▶ Rugged aluminum die-cast housing or Stainless steel 316
- ▶ Rotatable valve head for optimal mounting
- ▶ Screw mounting
- ▶ Usable up to SIL3 acc. to IEC 61508
- ▶ KCs - certified flameproof Ex d IIC , Ex tb IIC
- ▶ NEPSI - certified flameproof Ex d IIC , Ex tb IIC
- ▶ IECEx - certified flameproof Ex d IIC , Ex tb IIC
- ▶ ATEX - certified flameproof Ex d IIC , Ex tb IIC

Specifications

Model	ESV-31	ESV-32
Operating Air Pressure	1.5 - 10 bar	
Air Supply (Max.)	15 bar	
Operating Voltage / Power	AC110V : 6.8W / AC220V : 6.4W / DC 24V : 3.4W	
Voltage Tolerance	10%	
Frequency	50Hz / 60Hz	
Explosion Proof Class	Ex d IIC T6 / T5 / T4 , Ex tb IIIC T85 / T100 / T135, IP66	
Operating Ambient Temperature	T6 : -30 - +50 T5 : -30 - +65 , T4 : -30 - +80	
Flow Capacity(Cv)	0.9	
Mounting Configuration	Screw interface	
Pneumatic Connections	PT(Rc) 1/4 or NPT 1/4	
Electrical Connection	PF(G) 1/2 , NPT 1/2 , M20 x 1.5	
Coil Insulation Grade	Class F / Class H	
Operating type	Nomally - Closed	Nomally - Open
Duty Cycle	100%	
Valve body material	Aluminum die-cast or Stainless steel 316	
Coil housing material	Aluminum die-cast or Stainless steel 316	
Weight (Valve body / Coil housing)	Aluminum / Aluminum : 0.8 kg Aluminum / SS316 : 1.8 kg SS316 / SS316 : 2.1 kg	

Rotatable Valve Head

The ESV valve head can be rotated by 90° to the right or to the left for an optimal mounting as shown below

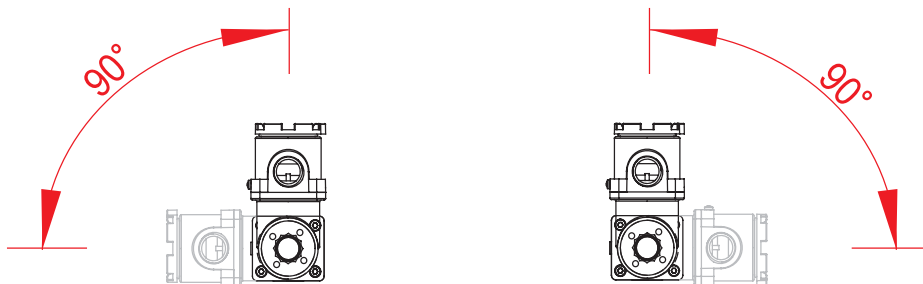



**Explosion proof solenoid valve
for a confident control under
rough working environments**

Features

- ▶ Manual reset button
- ▶ Rugged aluminum die-cast housing or Stainless steel 316
- ▶ Rotatable valve head for optimal mounting
- ▶ Screw mounting
- ▶ Usable up to SIL3 acc. to IEC 61508
- ▶ KCs - certified flameproof Ex d IIC , Ex tb IIC
- ▶ NEPSI - certified flameproof Ex d IIC , Ex tb IIC
- ▶ IECEX - certified flameproof Ex d IIC , Ex tb IIC
- ▶ ATEX - certified flameproof Ex d IIC , Ex tb IIC

Specifications

Model	ESV-31 ... R	ESV-32 ... R
Operating Air Pressure	1.5 - 10 bar	
Air Supply (Max.)	15 bar	
Operating Voltage / Power	AC110V : 6.8W / AC220V : 6.4W / DC 24V : 3.4W	
Voltage Tolerance	10%	
Frequency	50Hz / 60Hz	
Explosion Proof Class	Ex d IIC T6 / T5 / T4 , Ex tb IIC T85 / T100 / T135, IP66	
Operating Ambient Temperature	T6 : -30 - +50 T5 : -30 - +65 , T4 : -30 - +80	
Flow Capacity(Cv)	0.9	
Mounting Configuration	Screw interface	
Pneumatic Connections	PT(Rc) 1/4 or NPT 1/4	
Electrical Connection	PF(G) 1/2 , NPT 1/2 , M20 x 1.5	
Coil Insulation Grade	Class F / Class H	
Operating type	Nomally - Closed	Nomally - Open
Duty Cycle	100%	
Valve body material	Aluminum die-cast or Stainless steel 316	
Coil housing material	Aluminum die-cast or Stainless steel 316	
Weight (Valve body / Coil housing)	Aluminum / Aluminum : 0.8 kg Aluminum / SS316 : 1.8 kg SS316 / SS316 : 2.1 kg	





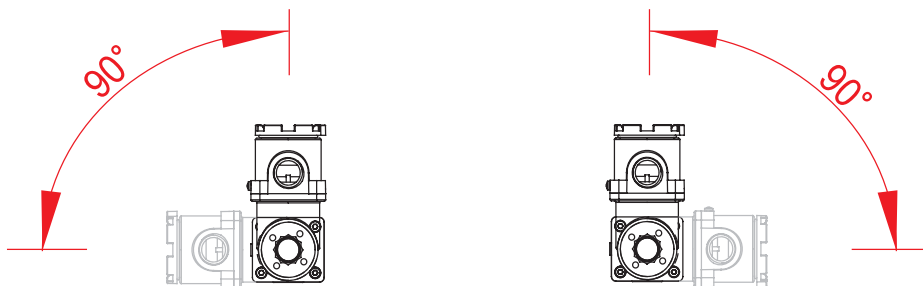

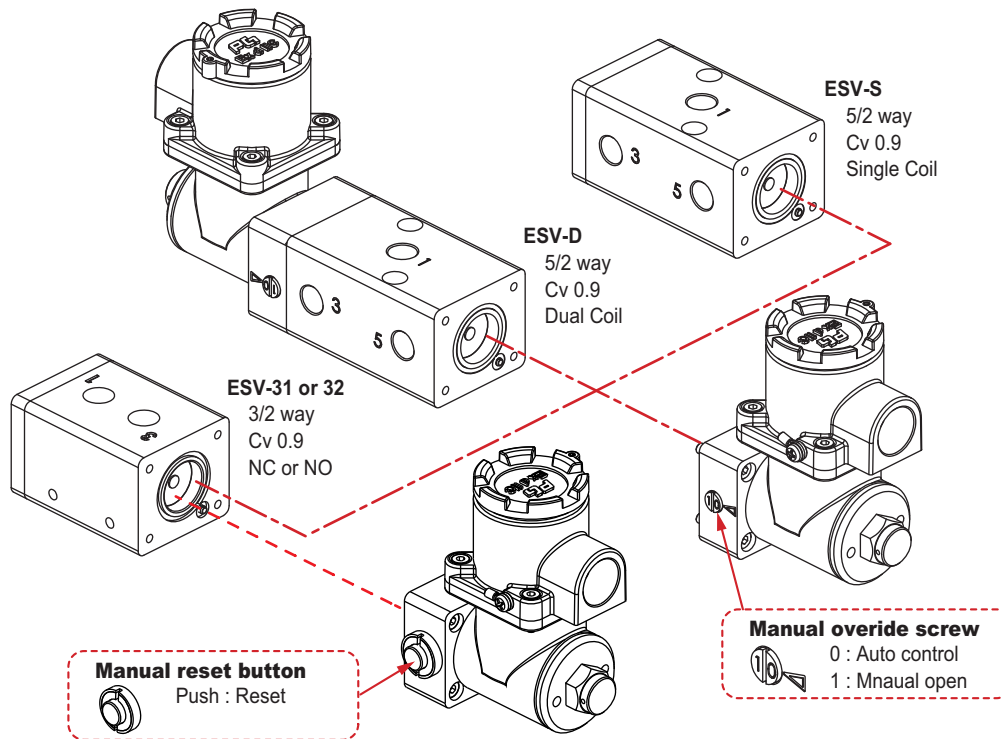
Rotatable Valve Head

The ESV valve head can be rotated by 90° to the right or to the left for an optimal mounting as shown below

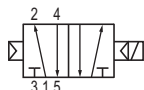

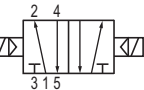
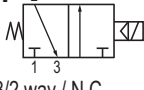
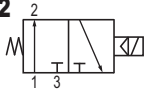

Ordering Guide

ESV Series	Operating Type	Body Material (valve body - coil housing)	Operating Voltage	Connections (pneumatic - electrical)	Protection & SIL Class	Coil Class	Manual Option
ESV	S  5/2 way / Single Coil Cv 0.9	Blank Aluminum - Aluminum die-cast S SS316 - Aluminum die-cast (only NPT 1/4 pneumatic connections) C SS316 - SS316 (Pneumatic : NPT 1/4) (Electrical : NPT 1/4, M20)	A220 220VAC A110 110VAC D24 24VDC	P PT 1/4 - PF 1/2 M PT 1/4 - M20x1.5 N NPT 1/4 - NPT 1/2 K NPT 1/4 - M20x1.5	F KCs / NEPSI IECEx / ATEX - Ex d IIC T6..T4 - Ex tb IIIC T85/T100/T135 Up to SIL3     	Blank Class F H Class H	Blank Manual override screw R Manual reset button (Only 3/2way)
	D  5/2 way / Dual Coil Cv 0.9						
	31  3/2 way / N.C. Cv 0.9						
	32  3/2 way / N.O. Cv 0.9						

Ex) **ESV - S - A220P - F** : 5/2 way single coil , Aluminum - aluminum die-cast , 220VAC , PT1/4-PF1/2 , KC Ex d IIC , Class F coil

ESV-S

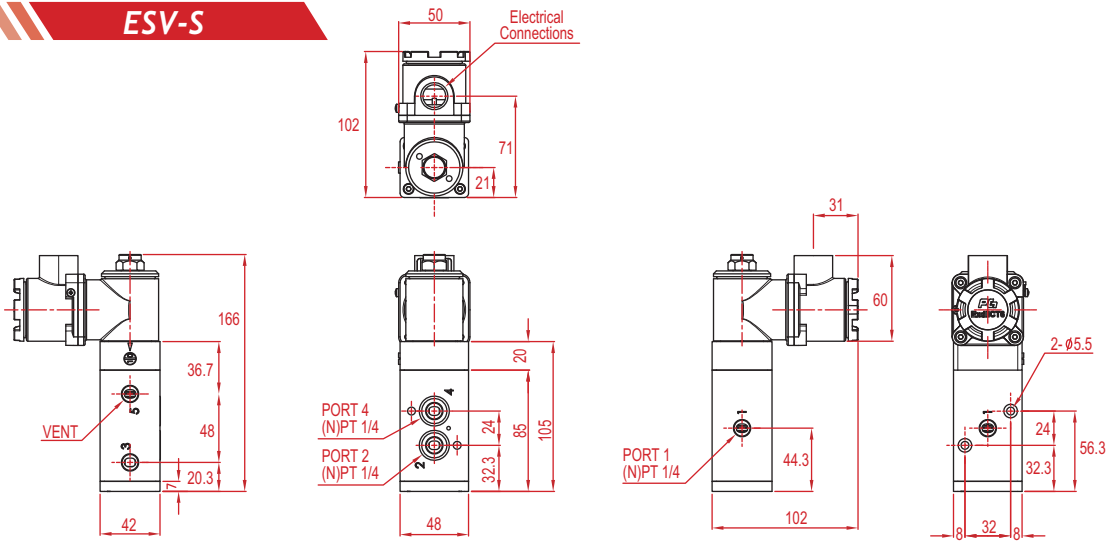

Symbol

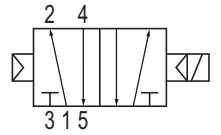

ESV-D

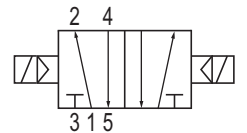
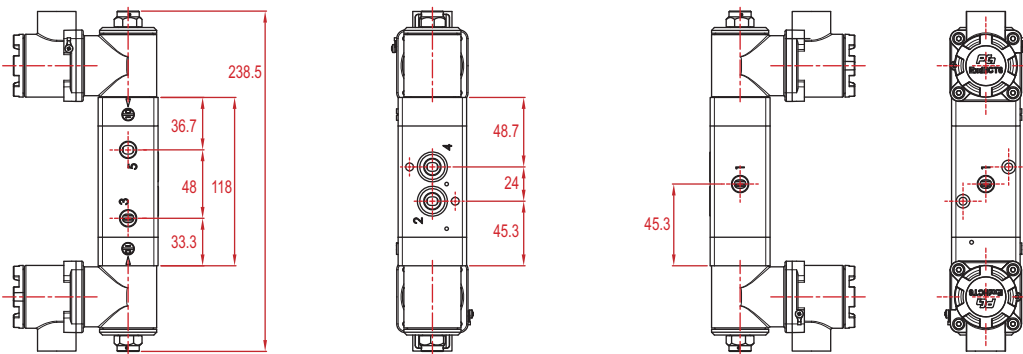

ESV-31 / 32

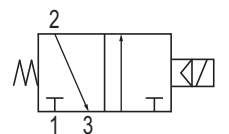
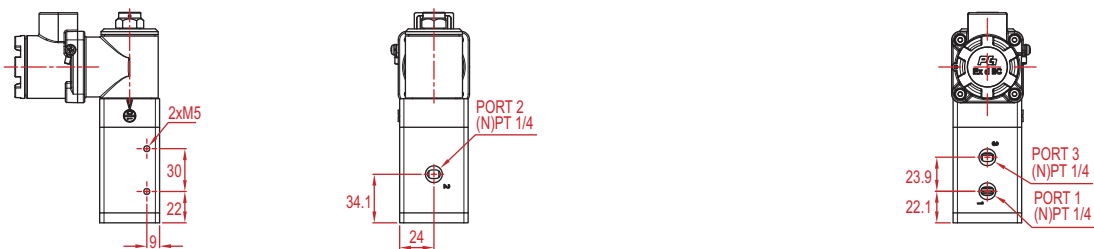

ESV-31
< Normally - closed >

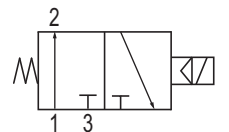

ESV-32
< Normally - open >